

# SCS

---

Load Sway Control System

---

## Instruction Manual



**ELECTROMOTIVE SYSTEMS**  
by **M** *MagneTek*

SCSINST-99A February 1, 2000

Part Number: 050-1036

© Copyright 1999 Electromotive Systems

©2000 ELECTROMOTIVE SYSTEMS

All rights reserved. This notice applies to all copyrighted materials included with this product, including, but not limited to, this manual and software embodied within the product. This manual is intended for the sole use of the persons to whom it was provided, and any unauthorized distribution of the manual or dispersal of its contents is strictly forbidden. This manual may not be reproduced in whole or in part by any means whatsoever without the expressed written permission of ELECTROMOTIVE SYSTEMS.

## ***DANGER, WARNING, CAUTION, and NOTE* Statements**

*DANGER, WARNING, CAUTION,* and *Note* statements are used throughout this manual to emphasize important and critical information. You must read these statements to help ensure safety and to prevent product damage. The statements are defined below.



### **DANGER**

*DANGER* indicates an imminently hazardous situation which, if not avoided, will result in death or serious injury. This signal word is to be limited to the most extreme situations.



### **WARNING**

*WARNING* indicates a potentially hazardous situation which, if not avoided, could result in death or serious injury.



### **CAUTION**

*CAUTION* indicates a potentially hazardous situation which, if not avoided, could result in minor or moderate injury. It may also be used to alert against unsafe practices.

*NOTE:* A *NOTE* statement is used to notify people of installation, operation, programming, or maintenance information that is important, but not hazard-related.

## Disclaimer of Warranty

Electromotive Systems hereafter referred to as Company, assumes no responsibility for improper programming of the swing control module by untrained personnel. The module should only be programmed by a trained technician who has read and understands the contents of this manual. Improper programming of this module can lead to unexpected, undesirable, or unsafe operation or performance. This may result in damage to equipment or personal injury. Company shall not be liable for economic loss, property damage, or other consequential damages or physical injury sustained by the purchaser or by any third party as a result of such programming. Company neither assumes nor authorizes any other person to assume for Company any other liability in connection with the sale or use of this product.



### **WARNING**

Improper programming of a drive can lead to unexpected, undesirable, or unsafe operation or performance of the drive.

# Contents

Disclaimer of Warranty .....	ii
Welcome!.....	iii
Safety Precautions.....	iii

## Chapter 1: SCS Terminals

Terminal Pins Out .....	1-3
Control Keypads and Panel Connectors Location .....	1-3
Connector Functions.....	1-4

## Chapter 2: SCS Installation

Preliminary Check .....	2-3
Setting Up the SCS Software .....	2-4
Menu Navigation of the SCS Software Module .....	2-5
Menu Functions .....	2-12
Language.....	2-12
Monitor .....	2-12
Adjustment.....	2-16
1.00 Bridge [Bridge].....	2-16
2.00 Trolley [Trolley].....	2-24
3.00 Hoist Setup [Hoist Setup].....	2-32
4.00 Options [Options] .....	2-36
Calibration for Input and Output (I/O).....	2-37
5.00 IO-Configuration [I/O-config] .....	2-37
6.00 Serial I/O Configuration [Serial I/O] .....	2-41
Application Notes: .....	2-43

## Appendix A: Servicing SCS

Service .....	A-3
Service Policy For SCS Components .....	A-3
Electromotive Systems Limited Warranty .....	A-5

This page intentionally left blank.

# Welcome!

## Safety Precautions

1. All the safety and operating instructions should be read before the unit is operated.
2. The safety and operating instructions should be retained for future reference.
3. All warnings on the unit and in the operating instructions should be followed.
4. All operating and use of instructions should be followed.
5. Power off the unit before cleaning. Do not use liquid cleaners or aerosol cleaners. Use a damp cloth for cleaning.
6. Do not use attachments not recommended by the unit's manufacturer as they may cause hazards.
7. Do not use this unit near water.
8. This unit should be operated only from the type of power sources listed in the manual. If you are not sure what power sources should be used, please contact your dealer or manufacturer.
9. Do not attempt to service this unit as opening or removing covers may expose user to dangerous voltage or other hazards. Refer all servicing to qualified personnel only.
10. When replacement parts are required, be sure the service technician uses replacement parts specified by the manufacturer or those that have the same characteristics as the original part. Unauthorized substitutions may result in fire, electric shock or other hazardous conditions.
11. Due to safety conditions involved in the operations of this unit, it is recommended that this system be checked and calibrated at least once a year by a qualified service personnel.

This page intentionally left blank.

*c h a p t e r* **1**

---

**SCS Terminals**



This page intentionally left blank.

# Terminal Pins Out

## Control Keypads and Panel Connectors Location

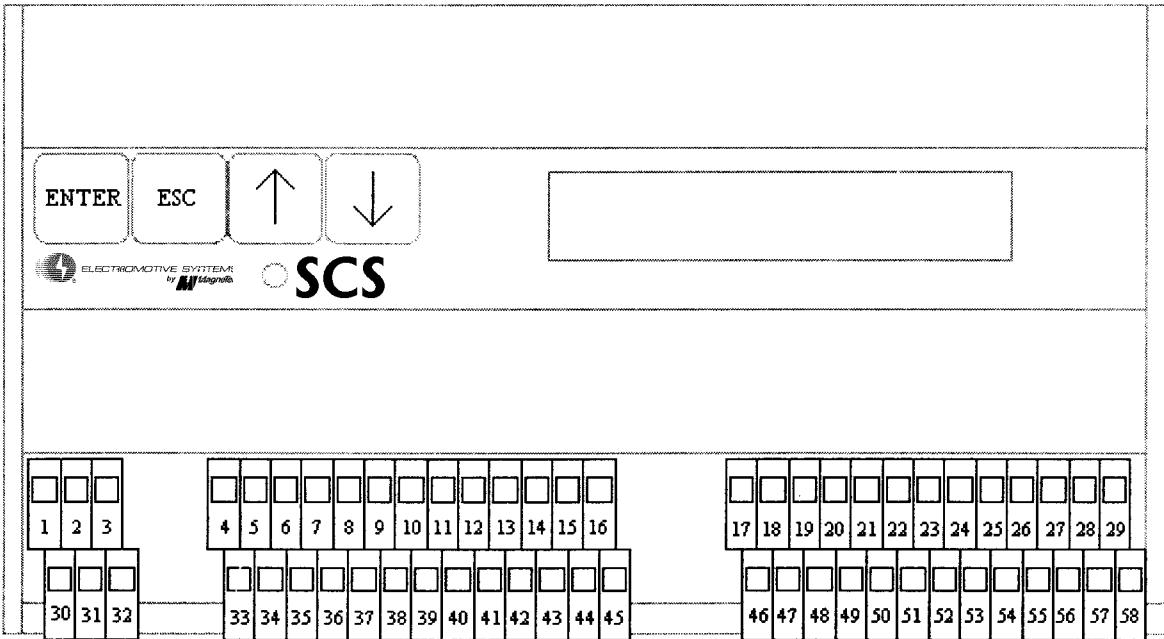
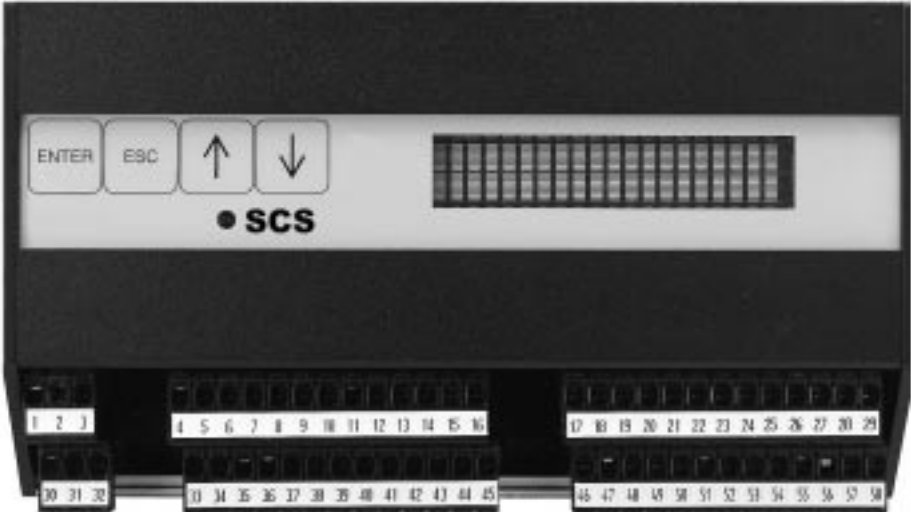

## Connector Functions

1	Power supply 50VAC
2	Power supply 120VAC
3	Power supply 240VAC
4	+ Analog input 0-10V/ 0-20mA/ 4-20 mA trolley
5	- Analog input 0-10V/ 0-20mA/ 4-20mA trolley
6	+ Analog output 0-10V/ -10...0...+10V/ 0-20mA/ 4-20mA trolley
7	- Analog output 0-10V/ -10...0...+10V/ 0-20mA/ 4-20mA trolley
8	Supply 24VDC/50mA for height measurement/incremental sensor
9	Analog input 4-20mA height measurement
10	Ground for height measurement/incremental sensor
11	Error and ICRAS relay common terminal for 12,39
12	Relay output 250V/5A error relay
13	Trolley common terminal for 14-16
14	Relay output 250V/5A trolley right
15	Relay output 250V/5A trolley left
16	Relay output 250V/5A trolley additional relay
17	Trolley common terminal for 18-21
18	Digital input 5-300VDC/ 24-250VAC trolley left
19	Digital input 5-300VDC/ 24-250VAC trolley right
20	Digital input 5-300VDC/ 24-250VAC trolley 2.step
21	Digital input 5-300VDC/ 24-250VAC trolley 3.step
22	Trolley end limit switch common terminal for 23-26
23	Digital input 5-300VDC/ 24-250VAC trolley speed limit switch left
24	Digital input 5-300VDC/ 24-250VAC trolley end limit switch left
25	Digital input 5-300VDC/ 24-250VAC trolley speed limit switch right
26	Digital input 5-300VDC/ 24-250VAC trolley end limit switch right
27	Sling-adjustment/main input common terminal for 28, 29, 56, 57, 58
28	Digital input 5-300VDC/ 24-250VAC,sling-adjustment D0
29	Digital input 5-300VDC/ 24-250VAC,sling-adjustment D1
30	Power supply AC phase voltage (50V, 120V, 240V)
31	Power supply +12-36VDC or 12-24VACphase voltage
32	Power supply ground (12-36VDC) or neutral (12-24VAC)
33	+ Analog input 0-10V/ 0-20mA/ 4-20mA bridge
34	- Analog input 0-10V/ 0-20mA/ 4-20mA bridge
35	+ Analog output 0-10V/ -10...0...+10V/ 0-20mA/ 4-20mA bridge
36	- Analog output 0-10V/ -10...0...+10V/ 0-20mA/ 4-20mA bridge
37	Supply 12VDC/100mA for height measurement/incremental sensor
38	Incremental sensor line A
39	Incremental sensor line B
40	Incremental sensor line Home
41	Relay output 250V/5A, Anti-Sway ON relay
42	Bridge common terminal for 42-44

---

43	Relay output 250V/5A bridge right
44	Relay output 250/5A bridge left
45	Relay output 250V/5A bridge additional relay
46	Bridge common terminal for 47-50
47	Digital input 5-300VDC/ 24-250VAC bridge left
48	Digital input 5-300VDC/ 24-250VAC bridge right
49	Digital input 5-300VDC/ 24-250VAC bridge 2.step
50	Digital input 5-300VDC/ 24-250VAC bridge 3.step
51	Bridge end limit switch common terminal for 52-55
52	Digital input 5-300VDC/ 24-250VAC bridge speed limit switch left
53	Digital input 5-300VDC/ 24-250VAC bridge end limit switch left
54	Digital input 5-300VDC/ 24-250VAC bridge speed limit switch right
55	Digital input 5-300VDC/ 24-250VAC bridge end limit switch right
56	Digital input 5-300VDC/ 24-250VAC main input
57	Digital input 5-300VDC/ 24-250VAC sling-adjustment D2
58	Digital input 5-300VDC/ 24-250VAC sling-adjustment D3

---



*c h a p t e r* **2**

---

**SCS Installation**

This page intentionally left blank.

# Preliminary Check

These are the necessary steps which must be completed after installation of the SCS module.

1. If the analog inputs are to be used, verify that they are in the correct range as the SCS is calibrated (0-10V,0-20mA). If the input ranges are not correct, it is recommended to adjust them to a standard range.
2. Check the software version from the adjustment-menu 4.01, make sure that the software loaded into SCS is the correct one, ask you dealer what software version is installed in your SCS.
3. Check the speed reference inputs
  - Disconnect directional outputs (R/L) to the inverter drive, or power off the inverter drive.
  - Check the monitor output for bridge and trolley when inputs are applied to SCS.
  - Check E-Stop button if it is detected by SCS.
  - Connect the direction outputs or power up the inverter drive.
  - Connect SCS by applying sling input of 0000.
  - Operate the bridge and trolley motions to ensure that the wiring is correct.
4. Height Measurement
  - Analog Input; Check the height measurement monitor while operating the bridge and trolley; observe if there is any disturbance/noise in the height measurement. If noise/ disturbance appears, the height measurement monitor will show unstable readings.
  - Incremental Encoder; Set the hoist at a certain position and move the bridge trolley. Check the measurement.
  - Signal Cable; It is recommended to use a shielded twist pair cable with the shield grounded at **BOTH ENDS**.



## Setting Up the SCS Software

After wiring the preliminary check has been completed, the next step in the SCS installation is to set up the parameters that the SCS software will need in controlling the sway of the crane.

A step-by-step example of how to do adjustments in the SCS software menu is as follows:

- Turn power 'on'
- Wait until display shows "Electromotive"
- Press 'Enter' once, display shows 'Language'
- Press ↑ twice, display shows 'Adjustment'
- Press 'Enter' once
- Press ↑ twice, then security code shows '2000'
- Press 'Enter' five times, display shows '1.00 Bridge'
- Press ↑ once, display shows 2.00 Trolley, press 'Enter'
- Press ↑ six times, display shows 2.07 Mode
- Press 'Enter', press ↑ four times, display shows 'Prop Smooth'
- Press 'Enter' once, press 'ESC' twice
- Press 'Enter' to save the change
- Press 'ESC' to go back to initial display



### WARNING

*All setup information in this book is intended to be used by a qualified service technician only. Electromotive Systems is not responsible for any damage or hazardous situation that may occur if setup adjustments are performed by a non-qualified person.*

# Menu Navigation of the SCS Software Module

Key	Explanation	Symbol	Function	Other Function
ENTER ESC ↑ ↓	Enter Escape Plus Minus	↵ ESC ↑ ↓	Menu selection Leave the menu level Next menu level Before menu level	Enter, Save Escape, Ignore Next value Before value
		←↑	arrows for orientation	

1. Menu level display		2. Menu level display		3. Menu level display		4. Menu level display
-----------------------	--	-----------------------	--	-----------------------	--	-----------------------

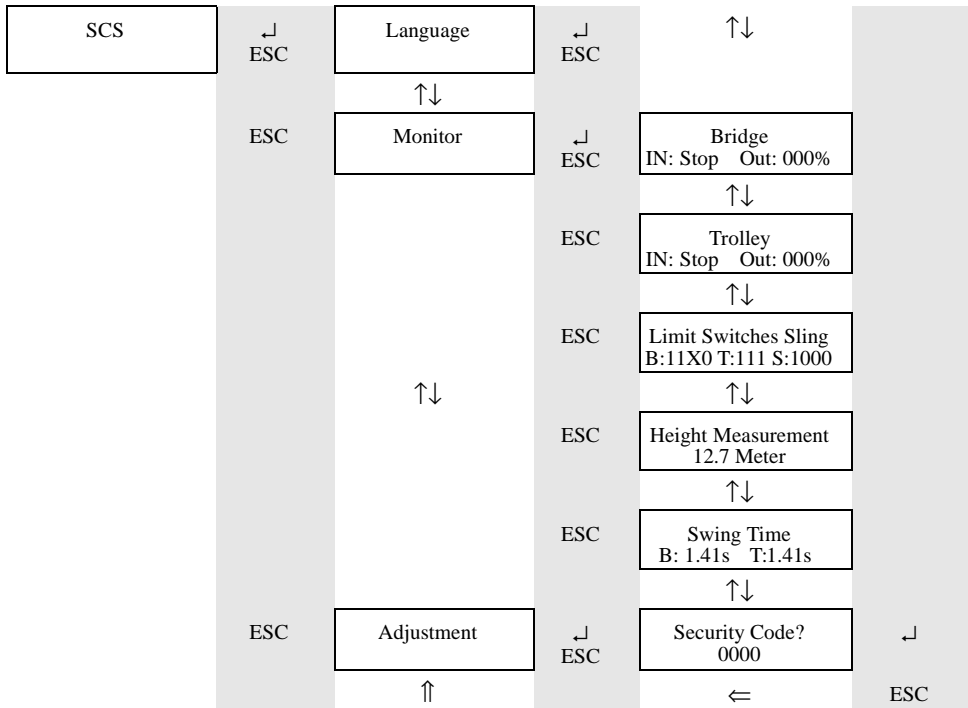

Security Code 2000 1.00 Bridge  
2.00 Trolley  
3.00 Height Mass  
4.00 Option

Security Code 4000 5.00 I/O-config  
6.00 Serial I/O

SCS ↵

Language ↑

Monitor ↑

Adjustment ↑

Security Code (2000) ↵

4. Menu level display		5. Menu level display		Change value
↵ ESC	1.00 Bridge	↵/ESC	1.01 Accel Time SC on ↑↓	↵/ESC/↵ ↑↓
		ESC	1.02 Decl. Time SC on ↑↓	↵/ESC/↵ ↑↓
		ESC	1.03 Accel. Tm.SC off ↑↓	↵/ESC/↵ ↑↓
		ESC	1.04 Decel. Tm.SC off ↑↓	↵/ESC/↵ ↑↓
		ESC	1.05 DirChange limit ↑↓	↵/ESC/↵ ↑↓
		ESC	1.06 Start Delay ↑↓	↵/ESC/↵ ↑↓
		ESC	1.07 Mode ↑↓	↵/ESC/↵ ↑↓
		ESC	1.08 Speed limit ↑↓	↵/ESC/↵ ↑↓
		ESC	1.09 SpdLimitSw. r ↑↓	↵/ESC/↵ ↑↓
		ESC	1.10 Spd LimitSw. 1 ↑↓	↵/ESC/↵ ↑↓
		ESC	1.11 EndLimitSw. r ↑↓	↵/ESC/↵ ↑↓
		ESC	1.12 EndlimitSw. 1 ↑↓	↵/ESC/↵ ↑↓
		ESC	1.13 Input ↑↓	↵/ESC/↵ ↑↓
		ESC	1.14 Output ↑↓	↵/ESC/↵ ↑↓
		ESC	1.15 Relays Function ↑↓	↵/ESC/↵ No entry
		ESC	1.16 S-Curve time ↑↓	↵/ESC/↵ ↑↓

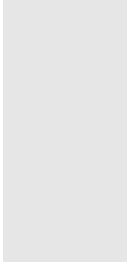

ESC	1.17 Minimum Speed	↵/ESC/↵	↑↓
	↑↓		
ESC	1.18 Sling adjust	↵/ESC/↵	↑↓
	↑↓		
ESC	1.19 Relays time	↵/ESC/↵	↑↓
	↑↓		
ESC	1.20 Micro Speed Gain	↵/ESC/↵	↑↓

SCS ↵

Language ↑

Monitor ↑

Adjustment ↵

Security Code (1) ↵

4. Menu level display		5. Menu level display		Change value
↵ ESC	2.00 Trolley	↵/ESC	2.01 Accel Time SC on ↑↓	↵/ESC/↵ ↑↓
		ESC	2.02 Decl. Time SC on ↑↓	↵/ESC/↵ ↑↓
		ESC	2.03 Accel.Tm.SC off ↑↓	↵/ESC/↵ ↑↓
		ESC	2.04 Decel.Tm.SC off ↑↓	↵/ESC/↵ ↑↓
		ESC	2.05 DirChange limit ↑↓	↵/ESC/↵ ↑↓
		ESC	2.06 Start Delay ↑↓	↵/ESC/↵ ↑↓
		ESC	2.07 Mode ↑↓	↵/ESC/↵ ↑↓
		ESC	2.08 Speed limit ↑↓	↵/ESC/↵ ↑↓
		ESC	2.09 SpdLimitSw. r ↑↓	↵/ESC/↵ ↑↓
		ESC	2.10 Spd LimitSw. 1 ↑↓	↵/ESC/↵ ↑↓
		ESC	2.11 EndLimitSw. r ↑↓	↵/ESC/↵ ↑↓
		ESC	2.12 EndlimitSw. 1 ↑↓	↵/ESC/↵ ↑↓
		ESC	2.13 Input ↑↓	↵/ESC/↵ ↑↓
		ESC	2.14 Output ↑↓	↵/ESC/↵ ↑↓
		ESC	2.15 Relays Function ↑↓	↵/ESC/↵ No entry

		ESC	2.16 S-Curve time	↵/ESC/↵	↑↓
			↑↓		
		ESC	2.17 Minimum Speed	↵/ESC/↵	↑↓
			↑↓		
		ESC	2.18 Sling adjust	↵/ESC/↵	↑↓
			↑↓		
		ESC	2.19 Relays time	↵/ESC/↵	↑↓
			↑↓		
		ESC	2.20 Micro Speed Gain	↵/ESC/↵	↑↓
ESC	3.00 Hoist Setup	ESC/↵	3.01 Measurement	↵/ESC/↵	↑↓
			↑↓		
		ESC	3.02 Manual Adj	↵/ESC/↵	↑↓
			↑↓		
		ESC	3.03 Test Range	↵/ESC/↵	↑↓
			↑↓		
		ESC	3.04 Auto Setup	↵/ESC/↵	↑↓
			↑↓		
		ESC	3.05 STime.Bridge	↵/ESC/↵	↑↓
			↑↓		
		ESC	3.06 STime.Trolley	↵/ESC/↵	↑↓
			↑↓		
			↑↓		
ESC	4.00 Options	ESC	4.01 Factory Default	↵	ESC/↵
			↑↓		
		ESC	4.02 Soft. Version	↵	ESC/↵

SCS ↵

Language ↑

Monitor ↑

Adjustment ↵

Security Code (2) ↵

4. Menu level display		5. Menu level display		Change value	
↵ ESC	5.00 I/O config	↵/ESC	5.01 Bridge In 10V ↑↓	↵/ESC/↵ ↑↓	
		ESC	5.02 Bridge In 20mA ↑↓	↵/ESC/↵ ↑↓	
		ESC	5.03 Bridge In 4mA ↑↓	↵/ESC/↵ ↑↓	
		ESC	5.04 Trolley In 10V ↑↓	↵/ESC/↵ ↑↓	
		ESC	5.05 Trolley In 20mA ↑↓	↵/ESC/↵ ↑↓	
		ESC	5.06 Trolley In 4mA ↑↓	↵/ESC/↵ ↑↓	
		ESC	5.07 Height Meas 20mA ↑↓	↵/ESC/↵ ↑↓	
		↵↓	ESC	5.08 Height Meas 4mA ↑↓	↵/ESC/↵ ↑↓
			ESC	5.09 Bridge Out 10V ↑↓	↵/ESC/↵ ↑↓
			ESC	5.10 Bridge Out 20mA ↑↓	↵/ESC/↵ ↑↓
			ESC	5.11 Bridge Out 4mA ↑↓	↵/ESC/↵ ↑↓
			ESC	5.12 Trolley Out 10V ↑↓	↵/ESC/↵ ↑↓
			ESC	5.13 Trolley Out 20mA ↑↓	↵/ESC/↵ ↑↓
			ESC	5.14 Trolley Out 4mA ↑↓	↵/ESC/↵ ↑↓

SCS ↵

Language ↑

Monitor ↑

Adjustment ↵

Security Code (2) ↵

4. Menu level display		5. Menu level display		Change value
↵ ESC	6.00 Serial I/O	↵/ESC	6.01 Trolley right ↑↓	↵/ESC/↵ ↑↓
		ESC	6.02 Trolley left ↑↓	↵/ESC/↵ ↑↓
		ESC	6.03 Trolley 2.step ↑↓	↵/ESC/↵ ↑↓
		ESC	6.04 Trolley 3.step ↑↓	↵/ESC/↵ ↑↓
		ESC	6.05 Trolley AK In ↑↓	↵/ESC/↵ ↑↓
		ESC	6.06 Trolley AK Out ↑↓	↵/ESC/↵ ↑↓
		ESC	6.07 Bridge right ↑↓	↵/ESC/↵ ↑↓
		ESC	6.08 Bridge left ↑↓	↵/ESC/↵ ↑↓
		ESC	6.09 Bridge 2.step ↑↓	↵/ESC/↵ ↑↓
		ESC	6.10 Bridge 3.step ↑↓	↵/ESC/↵ ↑↓
		ESC	6.11 Bridge AK In ↑↓	↵/ESC/↵ ↑↓
		ESC	6.12 Bridge AK Out ↑↓	↵/ESC/↵ ↑↓
		ESC	6.13 Sling D0 ↑↓	↵/ESC/↵ ↑↓
		ESC	6.14 Sling D1 ↑↓	↵/ESC/↵ ↑↓
		ESC	6.15 Sling D2 ↑↓	↵/ESC/↵ ↑↓
		ESC	6.16 Sling D3 ↑↓	↵/ESC/↵ ↑↓



# Menu Functions

SCS uses a fluorescent display and keypads as an interface to adjust the parameters, this interface allows parameter adjustments and also input/output monitoring.

## Language

This menu allows user to change the language used in the display. At this time, the available languages are German and English. This menu will be expanded up to 8 different languages in the future.

**Choices:**

- English**
- German**
- Language 3**
- Language 4**
- Language 5**
- Language 6**
- Language 7**
- Language 8**

## Monitor

Monitor menu allows users to check the actual input and output values from SCS's display without using a separate multimeter or other measurement device. This menu makes it easier to detect wiring faults and test the system during adjustment.

## Bridge

This display shows the actual input and output for the "Bridge". An example of the "Bridge" display is:

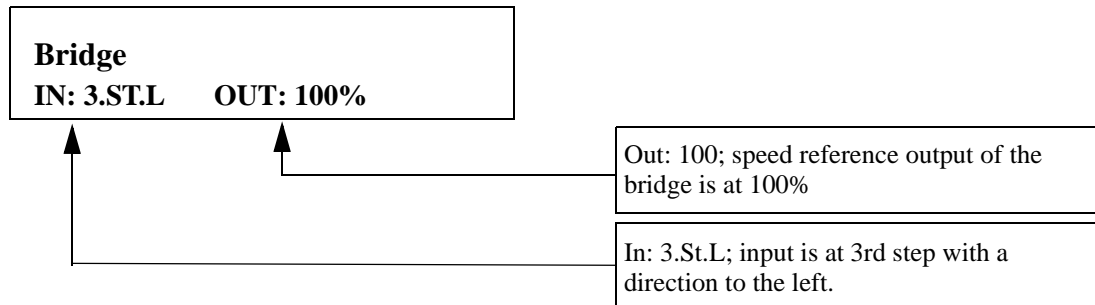

This means, that a digital input is in use with speed reference input signal at 3rd step, and 100% speed reference at the output.

If for example the display shows the following:

**Bridge**  
**IN: 074%    OUT: 043%**

This means an analog signal is in use with 74% speed reference at the input and 43% at the output.

*NOTE: The output of the SCS software varies to the calculated value even when the input remains at the same value, since the SCS's software algorithm is calculating and updating speed reference*

For example, the display shows the following:

<b>Bridge</b> <b>Emergency STOP</b>
--

The main input is open, or the Emergency stop switch is activated.

If for example the display shows the following:

<b>Bridge</b> <b>IN: Error    OUT: 100%</b>
--

There is an incorrect input signal (e.g. 2nd step signal without direction) and the output is 0%.

### **Trolley:**

The display functions for the “Trolley” are the same as the bridge section.

## Limit Switches and Sling Length:

This display shows the state and the use of the limit switches and the sling length. An example of this display is:

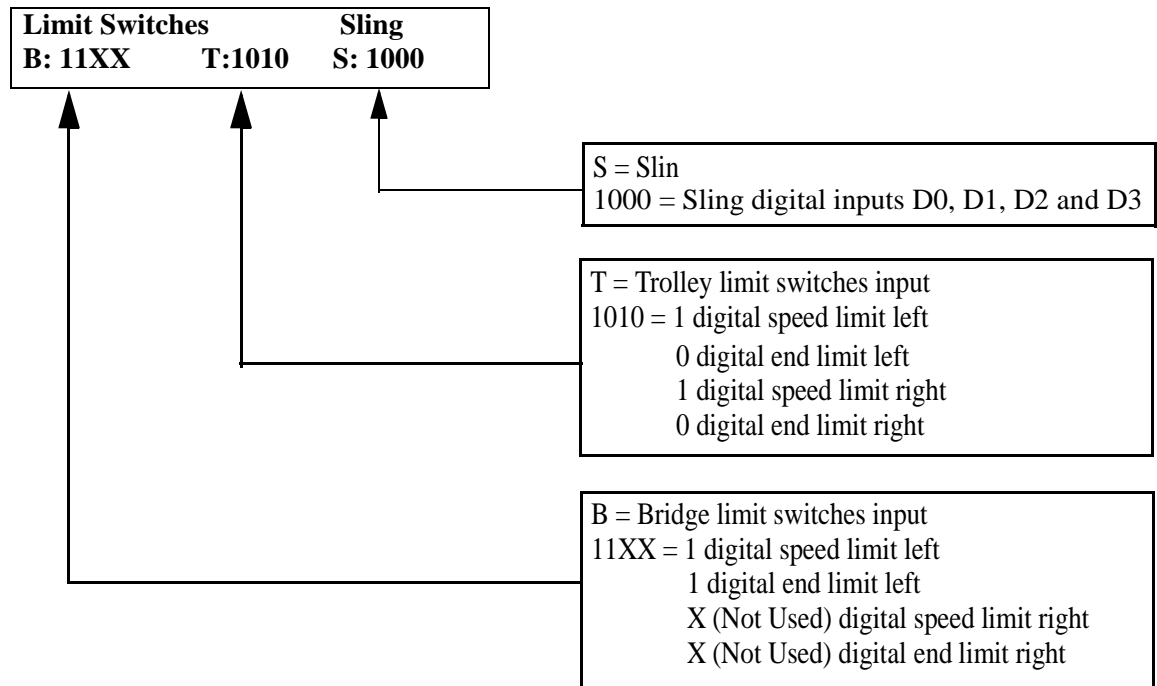

Limit Switch:     1: The input is enabled, and the switch is closed.  
                      0: The input is enabled, and the switch is open.  
                      X: The input is disabled, no switch is used.

Sling length:     1 bit is enabled and 0 bit is not enabled.

## Height Measurement:

This display shows the current height measured by SCS software. An example of height measurement display is:

**Height Meas.**  
**05.7 Meter**

## Swing Time

This menu allows the user to check the calculated swing time in both the bridge and trolley direction. An example of the swing time display is:

<p><b>Swing Time</b> <b>B: 01.41s    K: 01.52s</b></p>
--

B equals load swing time in the bridge motion, K equals load swing time in the trolley motion (Katz). If load swing control does not operate correctly, measure the swing period with a stopwatch and compare the value with this monitoring value. If the values are not identical or close (+/- .3 sec), error is most likely in the height measurement.

*NOTE: To get accurate swing time it is recommended to measure the time of 10 full swing periods and divide the result by 10 to get the accurate swing time. If the swing time does not change while the load is driven up or down it is likely that there is a fault in the height measurement device. Swing time should increase when the load is lowered and decrease while the load is hoisted.*

# Adjustment

Access to the parameter settings is secured with a security code. To access the adjustment mode, fill in the code with the correct numbers using the keypads.

Adjustment for Sway Control (SC); Security Code 1 (2000)

*NOTE: The Square brackets [ ] show the SCS Module Display Information!*

## 1.00 Bridge [Bridge]

## Bridge Control

### 1.01 Acceleration Time SCS Software ON [AccelTimeSC on]

Minimum value: 0.0 sec  
Maximum value: 25.5 sec  
Factory default: 2.0 sec

Acceleration time defines the maximum momentary acceleration allowed to be used by SCS software while accelerating into maximum speed. (This parameter also sets the maximum motor torque level for the crane drives). The real time to accelerate/decelerate is longer with SCS software connected, since the swing damping control needs to wait for the correct state of swing before making the final speed adjustment. The drives controlled by the SCS module should be set for 5-20% shorter acceleration time than SCS module acceleration time. Otherwise the drive cannot follow the SCS software control because of its own acceleration limit.

*NOTE: SCS optimizes the use of motor torque and allows faster momentary acceleration and deceleration than in normal manual control. If fast mode is selected it is recommended to use a slightly longer acceleration and deceleration time than with SMOOTH mode.*

### 1.02 Deceleration Time SCS software On [Decl.TimeSC on]

Minimum value: 0.1 sec  
Maximum value: 25.5 sec  
Factory setup: 2.0 sec

Deceleration time defines the maximum allowed momentary acceleration used by SCS software while decelerating into maximum speed. This parameter also set the maximum motor torque level for the crane drives. The drives controlled by SCS software should be set for about 10-20% shorter deceleration time than SCS software deceleration time, otherwise the drive cannot follow the SCS software control because of its deceleration limit.

*NOTE: SCS optimizes the use of motor torque and allows use of faster momentary acceleration and deceleration rates. If deceleration time with SCS software is set significantly shorter than acceleration, there can be delay in changing from deceleration to acceleration. This can be bothersome to the crane operator in some applications. If FAST mode is selected it is recommended to use longer acceleration and deceleration times than with SMOOTH mode*

### 1.03 Acceleration Time SCS Software Off [Accel.Tm.SC off]

Minimum value: 0.1 sec  
Maximum value: 25.5 sec  
Factory setup: 4.0 sec

*NOTE: SCS software optimizes the use of motor torque and allows faster acceleration and deceleration. Therefore, this parameter should have a higher value (=longer acceleration time) than with SCS software on.*

### 1.04 Deceleration Time SCS Software Off [Decel.Tm.SC off]

Minimum value: 0.1 sec  
Maximum value: 25.5 sec  
Factory setup: 4.0 sec

Acceleration time defines the acceleration ramp which is followed while the crane is accelerated.

*NOTE: SCS software optimizes the use of motor torque and allows faster acceleration and deceleration when active. Therefore, this parameter should have a higher value than with SCS software on.*

## 1.05 Direction Change Limit [DirChange limit]

Minimum value:	1%
Maximum value:	100%
Factory setup:	20%

Some drives have limited capacity to follow the speed control on low speeds. This can result in load sway when the operator changes the crane's traveling direction without first stopping the crane. This parameter limits the crane speed reference given to the SCS software algorithm while the crane is still running in the opposite direction than that of the operator's speed reference. If this parameter is set to 0% the crane stops before starting the acceleration into the other direction. If this parameter is set to 10%, only 10% of the maximum speed reference is allowed into the opposite direction while the crane speed control is still in the opposite direction.

*NOTE: SCS software optimizes the use of motor torque. If the drive has difficulties producing full torque on slow speeds, end sway may result after changing the traveling direction without first stopping the crane. This parameter is used to improve crane operation. This parameter is used to cope with the poor dynamics of the motor drives; limitation is not due to the SCS software speed control.*

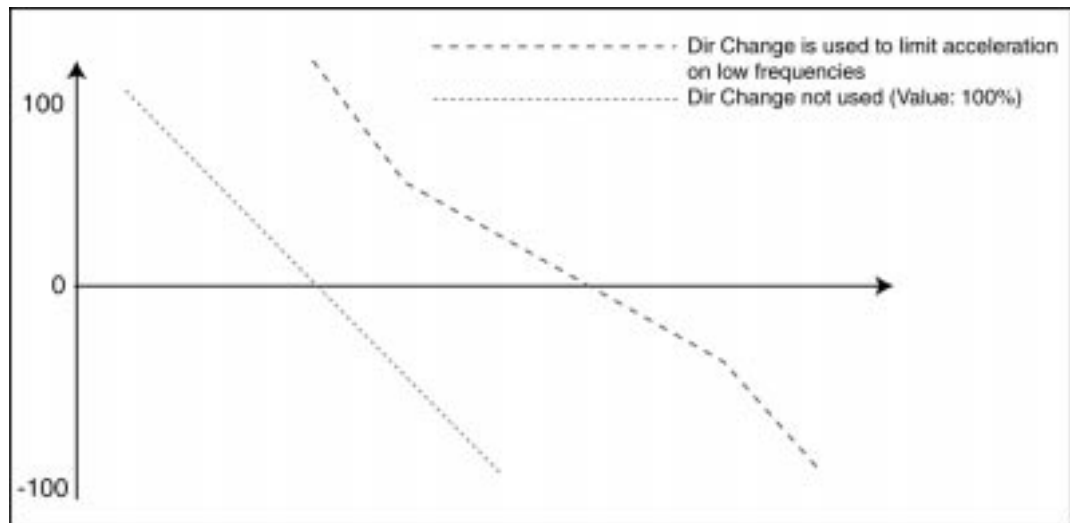

**Figure 2-1: Direction change**

Direction Change Limit can be used to slow down acceleration rate and motor torque requirement on low frequencies. This figure is only an example and does not illustrate any actual crane speed pattern.

## 1.06 Start Delay [Start Delay]

Minimum value: 00 m  
Maximum value: 500 ms  
Factory setup: 00 m

All variable frequency drives need to magnetize the AC motor rotor before they can start. Magnetizing time gets longer with larger motors. With this parameter SCS software can be set to wait until the drive is ready to start before an analog speed reference signal starts to rise from zero and the crane movement is started. This reduces the load sway caused by drive start-up delays when crane movement begins. The run/direction relays operate without delay. The starting time of an analog signal given by SCS software is delayed.

*NOTE: Long start delay disturbs the human operator of the crane. Therefore, it is recommended to keep this value as short as possible. In automated cranes the start delay can be longer.*

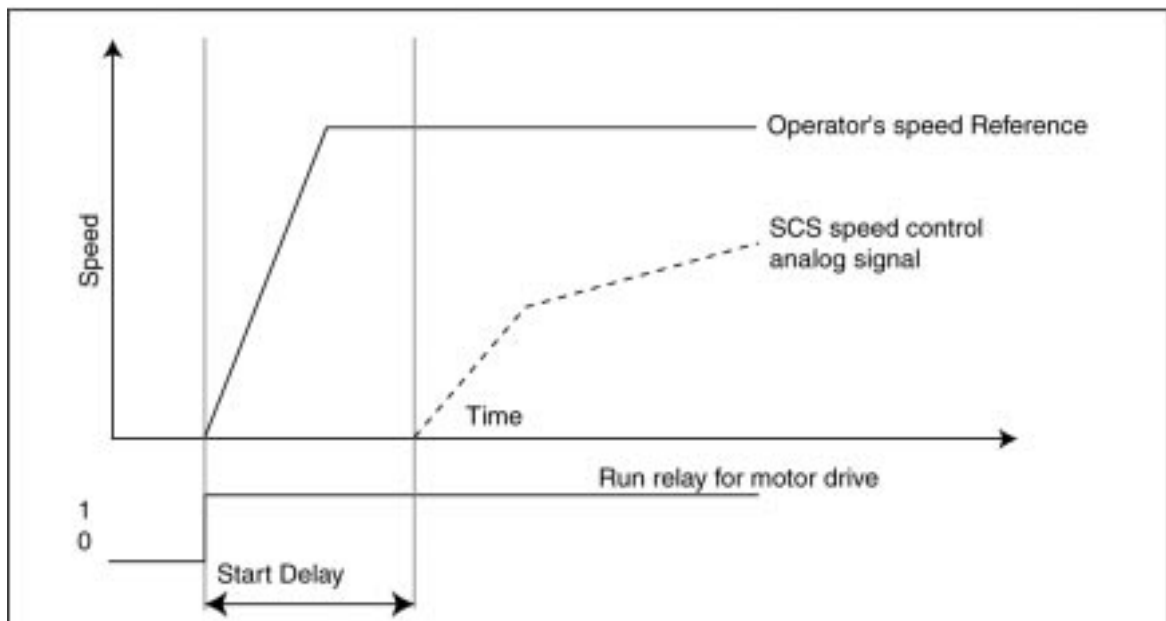

**Figure 2-2: Operation principle of the Start Delay**



## Bridge Control

### 1.07 Mode [Mode]

4 step fast  
 4 step smooth  
 3 step fast  
3 step smooth (Factory Setup)  
 Motor Poti fast  
 Motor Poti smooth  
 Prop fast  
 Prop smooth

This product can be set with a number of optional control types to fit all crane applications. Speed control is produced out of digital and analog inputs. Speed input can be:

- 3 speed stepped control
- 4 speed stepped control
- Electrical motor potentiometer with 3 digital inputs (Forward/Maintain Speed, Reverse/Maintain Speed, Accelerate)
- Proportional control with digital run/direction signals and analog speed signal (2 digital inputs, Forward, Reverse, one analog signal for speed +/-10V DC, 0-10V DC, 0 or 4-20mA).

Terminal-Number Trolley/Bridge		18/47	19/48	20/49	21/50
Control Mode	Speed Input	R1	L1	S2	S3
3 speed steps	1.step forward	1	0	0	0
	2.step forward	1	0	1	0
	3.step forward	1	0	1	1
	1.step reverse	0	1	0	0
	2.step reverse	0	1	1	0
	3.step reverse	0	1	1	1
4 Speed Steps	1.step forward	1	0	0	0
	2.step forward	1	0	1	0
	3.step forward	1	0	1	1
	4.step forward	1	0	0	1
	1.step reverse	0	1	0	0
	2.step reverse	0	1	1	0
	3.step reverse	0	1	1	1
	4.step reverse	0	1	0	1
Motor potentiometer	Forward 1 speed/maintain speed	1	0	0	0
	Forward accelerate	1	0	1	0
	Reverse 1 speed/maintain speed	0	1	0	0
	Reverse accelerate	0	1	1	0
Proportional	Forward minimum speed	1	0	0	0
	Reverse minimum speed	0	1	0	0
	Speed to above indicated direction given as a separate analog signal				

### 1.08 Speed Limit [Speed limit]

Minimum value:	1%
Maximum value:	100%
Factory setup:	10%

Many cranes utilize end limit switches to safely slow down and stop the crane movement at the end of the rail. Limits can be set to operate either with or without SCS software control according to the needs of the application. Speed limit can be set to operate with SCS software, without SCS software and the limit can be disabled. If the limit is not disabled the associated digital inputs must be set, otherwise the controller detects that the crane is on the limit switch area. Speed Limit parameter sets the traveling speed, slow down limit is set into this traveling direction.

### 1.09 Speed Limit Switch right [SpdLimitSw. R]

Some applications do not use speed limits at all, some need speed limits with SCS software functions and some need speed limits without SCS software. This parameter is used to select, if the limit is in use and if SCS software is used to avoid the load sway when the limit decelerates the crane speed.

<u>Not Used</u>	(Factory setup)
used without SC	
used with SC	

### 1.10 Speed Limit Switch left [SpdLimitSw. L]

As above, the right speed limit.

### 1.11 End Limit Switch right [EndLimit Sw. r]

As above, the right speed limit.

### 1.12 End Limit Switch left [EndLimitSw. l]

Most cranes utilize stop limit switches to avoid driving the crane against the end stops. With this parameter, the user can disable the end limit if necessary. If the limit is enabled, the operator can choose operation with or without SCS software swing control, like speed limit above.

### 1.13 Speed Input [Input]

<u>Digital</u>	(Factory setup)
Serial Port	
0-20mA + Direction	
4-20mA + Direction	
0-10V + Direction	

For easy installation the SCS Module can read a wide variation of speed control devices. Speed control can be read using digital inputs only or digital and analog signals. Acceptable digital input signal levels are 24-250VAC and 5-300V DC. Analog input signals can be 0-10V DC, 0-20mA or 4-20mA.

## 1.14 Output [Output]

Serial Port

0-20mA + Direction

4-20mA + Direction

0-10V + Direction (Factory setup)

-10V 0V + 10V

Speed output from the SCS software module is given as two direction signals and analog signals. Direction signals are relays and analog signals can be chosen as 0-20mA, 4-20mA, -10-0-+10V DC or 0-10V DC.

## 1.15 Relays Function [Relays Function]

SC calculate (No entry)

## 1.16 S-Curve Time [S-Curve time]

Minimum value: 0 ms

Maximum value: 500 ms

Factory setup: 50 m

S-curve can be used to smooth the crane acceleration. It is recommended to use S-curve in FAST operation mode to smoothen rapid changes in acceleration. S-curve can also be used to make a cab operated crane which uses high acceleration/deceleration curves more comfortable for the crane operator. Usually S-curve is not needed when smooth operation mode is selected. S-curve extends the time to reach the end speed with it's value. For example, if we have 300 ms S-curve time, the crane stops

300 ms later than with 0 ms S-curve.

*NOTE: S-curve time increases the time needed to reach the end speed. Therefore it is recommended to use only short values.*

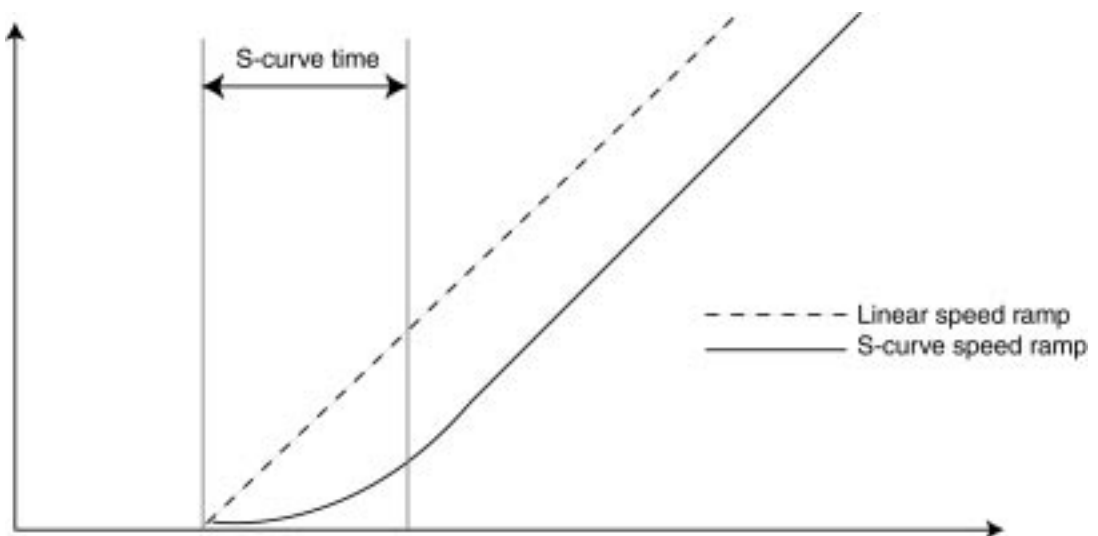

**Figure 2-3: Slow down with S-curve time**

## 1.17 Minimum Speed [Minimum Speed]

Minimum value:	0.0%
Maximum value:	25.0%
Factory setup:	5.0%

Friction is high when crane movement is started at a very low speed. Most AC motor drives, used for speed control, cannot generate good motor torque at low speeds. Also, many motors are not properly cooled if the motor rotor is not rotating fast enough. For these reasons we can set the minimum speed for traveling motion.

*NOTE: SCS software control can drive any speed. Minimum speed is needed because of crane drive dynamics.*

## 1.18 Sling length scaling [Sling adjust]

Minimum value:	1%
Maximum value:	100%
Factory setup:	100%

Sling length is the distance added to the hook when the load is hung on the crane hook using sling or another gripping attachment. This value corrects the measured load pendulum length with the distance from the hook to the center of the gravity of the load. This correction value makes it possible to use SCS software with varying loads and work conditions. In a normal crane where one hook is used to lift the load, the value should always be 100% for both trolley and bridge.

SCS software operates fine with cranes where the load is lifted using several hooks (as long as the hooks are leveled). The problem is, the sway dynamics change is dependent on the reeving used. When the load is lifted using one hook, the sling length is simply added into the hook height. If the load is hanging boom like in 2 (or more) hooks, the sling length correction is smaller. In many cases the sling length affect to the swing dynamics is different in load and gross travel directions. Therefore, it is possible to scale down the sling length affect for both directions separately. The scaling value is given as a percentage of the normal full length.

## 1.19 3<sup>rd</sup> Relay Time [Relais time]

Minimum value:	0.0 sec
Maximum value:	25.5 sec
Factory setup:	0.0 sec

Motor drives are controlled with an analog speed signal and two direction signals. The 3<sup>rd</sup> relay is used to tell that SCS software is still calculating the speed command. This information can be used to keep the AC motor magnetized until SCS software has completed the swing control. An adjustable delay of 0–25.5 seconds can be set to keep the AC motor magnetized for a period after the crane movement has stopped, thus allowing for a faster start of this variable frequency controlled AC motor drive.

## 1.20 Micro Speed Gain (Optional)

Minimum value:	1%
Maximum value:	100%
Factory setup:	50%

The micro speed functions as a speed limiter. With the micro speed activated, the crane operational speed will be limited to X% of the maximum normal operating speed, where X is the number set in this sub-menu.

## 2.00 Trolley [Trolley]

## Trolley Control

### 2.01 Acceleration Time SCS Software ON [AccelTimeSC on]

Minimum value:	0.0 sec
Maximum value:	25.5 sec
Factory default:	2.0 sec

Acceleration time defines the maximum momentary acceleration allowed to be used by SCS software while accelerating into maximum speed. (This parameter also sets the maximum motor torque level for the crane drives). The real time to accelerate/decelerate is longer with SCS software connected, since the swing damping control needs to wait for the correct state of swing before making the final speed adjustment. The drives controlled by the SCS module should be set for 5-20% shorter acceleration time than SCS module acceleration time. Otherwise the drive cannot follow the SCS software control because of its own acceleration limit.

*NOTE: SCS optimizes the use of motor torque and allows faster momentary acceleration and deceleration than in normal manual control. If fast mode is selected it is recommended to use a slightly longer acceleration and deceleration time than with SMOOTH mode.*

### 2.02 Deceleration Time SCS software On [Decl.TimeSC on]

Minimum value:	0.1 sec
Maximum value:	25.5 sec
Factory setup:	2.0 sec

Deceleration time defines the maximum allowed momentary acceleration used by SCS software while decelerating into maximum speed. This parameter also set the maximum motor torque level for the crane drives. The drives controlled by SCS software should be set for about 10-20% shorter deceleration time than SCS software deceleration time, otherwise the drive cannot follow the SCS software control because of its deceleration limit.

*NOTE: SCS optimizes the use of motor torque and allows use of faster momentary acceleration and deceleration rates. If deceleration time with SCS software is set significantly shorter than acceleration, there can be delay in changing from deceleration to acceleration. This can be bothersome to the crane operator in some applications. If FAST mode is selected it is recommended to use longer acceleration and deceleration times than with SMOOTH mode*

### 2.03 Acceleration Time SCS Software Off [Accel.Tm.SC off]

Minimum value: 0.1 sec  
Maximum value: 25.5 sec  
Factory setup: 4.0 sec

*NOTE: SCS software optimizes the use of motor torque and allows faster acceleration and deceleration. Therefore, this parameter should have a higher value (=longer acceleration time) than with SCS software on.*

### 2.04 Deceleration Time SCS Software Off [Decel.Tm.SC off]

Minimum value: 0.1 sec  
Maximum value: 25.5 sec  
Factory setup: 4.0 sec

Acceleration time defines the acceleration ramp which is followed while the crane is accelerated.

*NOTE: SCS software optimizes the use of motor torque and allows faster acceleration and deceleration when active. Therefore, this parameter should have a higher value than with SCS software on.*

## 2.05 Direction Change Limit [DirChange limit]

Minimum value:	1%
Maximum value:	100%
Factory setup:	20%

Some drives have limited capacity to follow the speed control on low speeds. This can result in load sway when the operator changes the crane's traveling direction without first stopping the crane. This parameter limits the crane speed reference given to the SCS software algorithm while the crane is still running in the opposite direction than that of the operator's speed reference. If this parameter is set to 0% the crane stops before starting the acceleration into the other direction. If this parameter is set to 10%, only 10% of the maximum speed reference is allowed into the opposite direction while the crane speed control is still in the opposite direction.

*NOTE: SCS software optimizes the use of motor torque. If the drive has difficulties producing full torque on slow speeds, end sway may result after changing the traveling direction without first stopping the crane. This parameter is used to improve crane operation. This parameter is used to cope with the poor dynamics of the motor drives; limitation is not due to the SCS software speed control.*

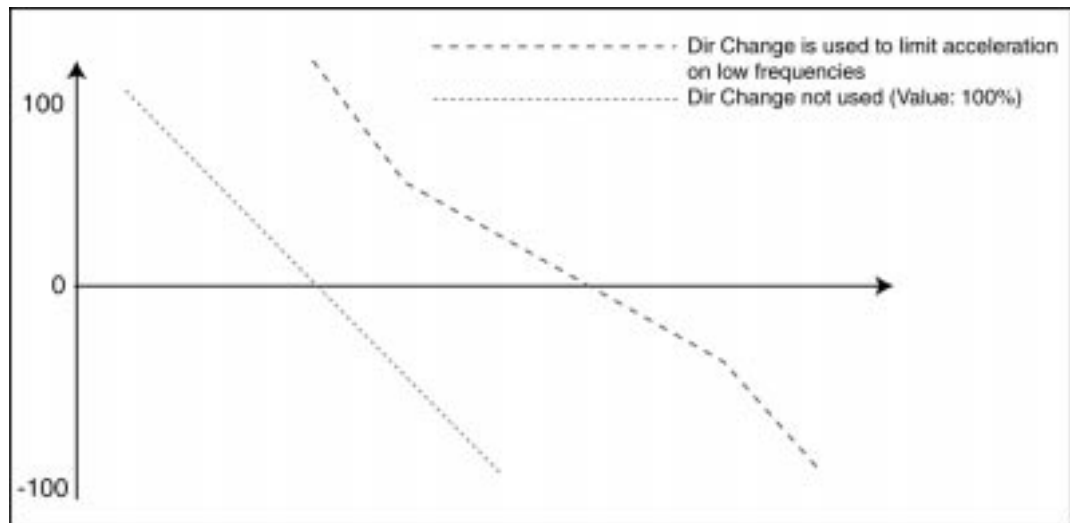

**Figure 2-4: Direction change**

Direction Change Limit can be used to slow down acceleration rate and motor torque requirement on low frequencies. This figure is only an example and does not illustrate any actual crane speed pattern.

## 2.06 Start Delay [Start Delay]

Minimum value: 00 m  
Maximum value: 500 ms  
Factory setup: 00 m

All variable frequency drives need to magnetize the AC motor rotor before they can start. Magnetizing time gets longer with larger motors. With this parameter SCS software can be set to wait until the drive is ready to start before an analog speed reference signal starts to rise from zero and the crane movement is started. This reduces the load sway caused by drive start-up delays when crane movement begins. The run/direction relays operate without delay. The starting time of an analog signal given by SCS software is delayed.

*NOTE: Long start delay disturbs the human operator of the crane. Therefore, it is recommended to keep this value as short as possible. In automated cranes the start delay can be longer.*

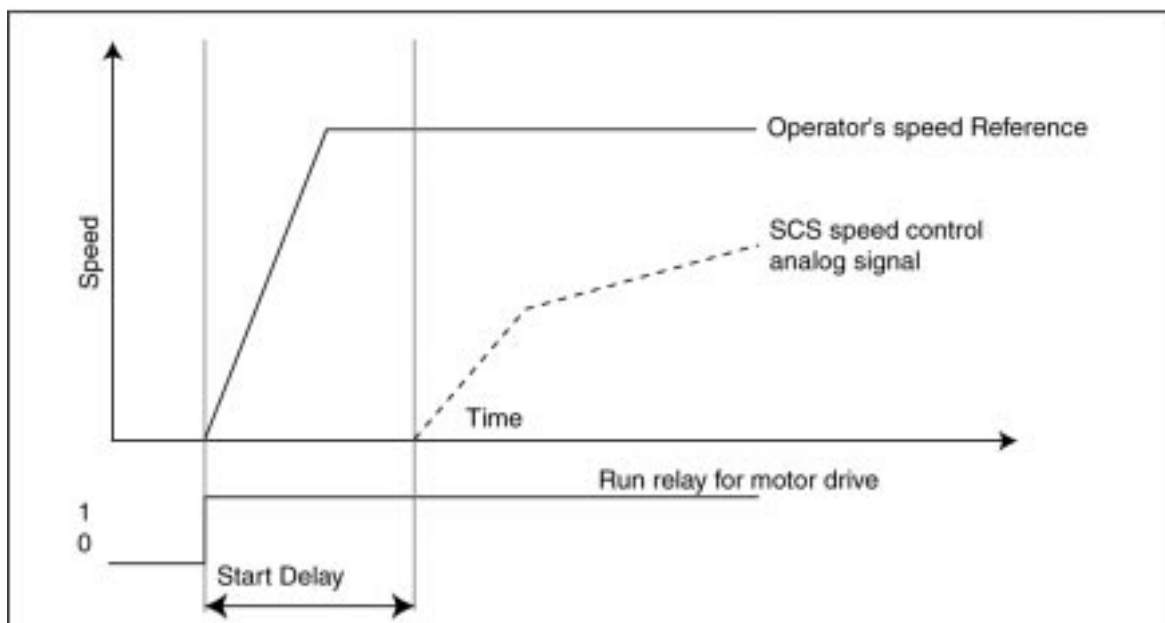

**Figure 2-5: Operation principle of the Start Delay**



# Trolley Control

## 2.07 Mode [Mode]

4 step fast  
 4 step smooth  
 3 step fast  
3 step smooth (Factory Setup)  
 Motor Poti fast  
 Motor Poti smooth  
 Prop fast  
 Prop smooth

This product can be set with a number of optional control types to fit all crane applications. Speed control is produced out of digital and analog inputs. Speed input can be:

- 3 speed stepped control
- 4 speed stepped control
- Electrical motor potentiometer with 3 digital inputs (Forward/Maintain Speed, Reverse/Maintain Speed, Accelerate)
- Proportional control with digital run/direction signals and analog speed signal (2 digital inputs, Forward, Reverse, one analog signal for speed +/-10V DC, 0-10V DC, 0 or 4-20mA).

Terminal-Number Trolley/Bridge		18/47	19/48	20/49	21/50
Control Mode	Speed Input	R1	L1	S2	S3
3 speed steps	1.step forward	1	0	0	0
	2.step forward	1	0	1	0
	3.step forward	1	0	1	1
	1.step reverse	0	1	0	0
	2.step reverse	0	1	1	0
	3.step reverse	0	1	1	1
4 Speed Steps	1.step forward	1	0	0	0
	2.step forward	1	0	1	0
	3.step forward	1	0	1	1
	4.step forward	1	0	0	1
	1.step reverse	0	1	0	0
	2.step reverse	0	1	1	0
	3.step reverse	0	1	1	1
	4.step reverse	0	1	0	1
Motor potentiometer	Forward 1 speed/maintain speed	1	0	0	0
	Forward accelerate	1	0	1	0
	Reverse 1 speed/maintain speed	0	1	0	0
	Reverse accelerate	0	1	1	0
Proportional	Forward minimum speed	1	0	0	0
	Reverse minimum speed	0	1	0	0
	Speed to above indicated direction given as a separate analog signal				

## 2.08 Speed Limit [Speed limit]

Minimum value: 1%  
Maximum value: 100%  
Factory setup: 10%

Many cranes utilize end limit switches to safely slow down and stop the crane movement at the end of the rail. Limits can be set to operate either with or without SCS software control according to the needs of the application. Speed limit can be set to operate with SCS software, without SCS software and the limit can be disabled. If the limit is not disabled the associated digital inputs must be set, otherwise the controller detects that the crane is on the limit switch area. Speed Limit parameter sets the traveling speed, slow down limit is set into this traveling direction.

## 2.09 Speed Limit Switch right [SpdLimitSw. R]

Some applications do not use speed limits at all, some need speed limits with SCS software functions and some need speed limits without SCS software. This parameter is used to select, if the limit is in use and if SCS software is used to avoid the load sway when the limit decelerates the crane speed.

Not Used (Factory setup)  
used without SC  
used with SC

## 2.10 Speed Limit Switch left [SpdLimitSw. L]

As above, the right speed limit.

## 2.11 End Limit Switch right [EndLimit Sw. r]

As above, the right speed limit.

## 2.12 End Limit Switch left [EndLimitSw. l]

Most cranes utilize stop limit switches to avoid driving the crane against the end stops. With this parameter, the user can disable the end limit if necessary. If the limit is enabled, the operator can choose operation with or without SCS software swing control, like speed limit above.

## 2.13 Speed Input [Input]

Digital (Factory setup)  
Serial Port  
0-20mA + Direction  
4-20mA + Direction  
0-10V + Direction

For easy installation the SCS Module can read a wide variation of speed control devices. Speed control can be read using digital inputs only or digital and analog signals. Acceptable digital input signal levels are 24-250VAC and 5-300V DC. Analog input signals can be 0-10V DC, 0-20mA or 4-20mA.

## 2.14 Output [Output]

Serial Port

0-20mA + Direction

4-20mA + Direction

0-10V + Direction (Factory setup)

-10V 0V + 10V

Speed output from the SCS software module is given as two direction signals and analog signals. Direction signals are relays and analog signals can be chosen as 0-20mA, 4-20mA, -10-0-+10V DC or 0-10V DC.

## 2.15 Relays Function [Relays Function]

SC calculate (No entry)

## 2.16 S-Curve Time [S-Curve time]

Minimum value: 0 ms

Maximum value: 500 ms

Factory setup: 50 m

S-curve can be used to smooth the crane acceleration. It is recommended to use S-curve in FAST operation mode to smoothen rapid changes in acceleration. S-curve can also be used to make a cab operated crane which uses high acceleration/deceleration curves more comfortable for the crane operator. Usually S-curve is not needed when smooth operation mode is selected. S-curve extends the time to reach the end speed with it's value. For example, if we have 300 ms S-curve time, the crane stops 300 ms later than with 0 ms S-curve.

*NOTE: S-curve time increases the time needed to reach the end speed. Therefore it is recommended to use only short values.*

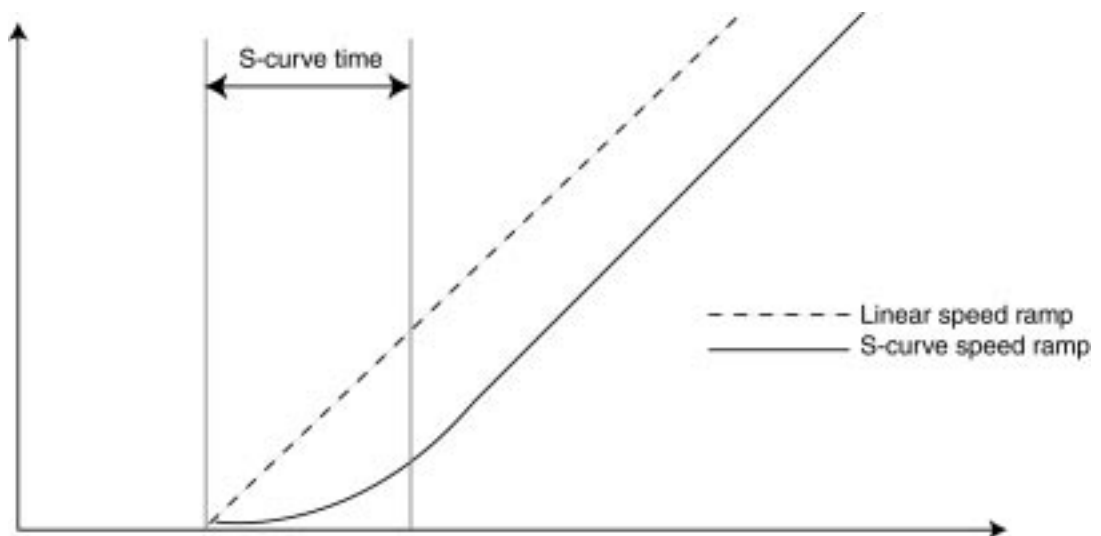

**Figure 2-6: Slow down with S-curve time**

## 2.17 Minimum Speed [Minimum Speed]

Minimum value:	0.0%
Maximum value:	25.0%
Factory setup:	5.0%

Friction is high when crane movement is started at a very low speed. Most AC motor drives, used for speed control, cannot generate good motor torque at low speeds. Also, many motors are not properly cooled if the motor rotor is not rotating fast enough. For these reasons we can set the minimum speed for traveling motion.

*NOTE: SCS software control can drive any speed. Minimum speed is needed because of crane drive dynamics.*

## 2.18 Sling length scaling [Sling adjust]

Minimum value:	1%
Maximum value:	100%
Factory setup:	100%

Sling length is the distance added to the hook when the load is hung on the crane hook using sling or another gripping attachment. This value corrects the measured load pendulum length with the distance from the hook to the center of the gravity of the load. This correction value makes it possible to use SCS software with varying loads and work conditions. In a normal crane where one hook is used to lift the load, the value should always be 100% for both trolley and bridge.

SCS software operates fine with cranes where the load is lifted using several hooks (as long as the hooks are leveled). The problem is, the sway dynamics change is dependent on the reeving used. When the load is lifted using one hook, the sling length is simply added into the hook height. If the load is hanging boom like in 2 (or more) hooks, the sling length correction is smaller. In many cases the sling length affect to the swing dynamics is different in load and gross travel directions. Therefore, it is possible to scale down the sling length affect for both directions separately. The scaling value is given as a percentage of the normal full length.

## 2.19 3<sup>rd</sup> Relay Time [Relais time]

Minimum value:	0.0 sec
Maximum value:	25.5 sec
Factory setup:	0.0 sec

Motor drives are controlled with an analog speed signal and two direction signals. The 3<sup>rd</sup> relay is used to tell that SCS software is still calculating the speed command. This information can be used to keep the AC motor magnetized until SCS software has completed the swing control. An adjustable delay of 0–25.5 seconds can be set to keep the AC motor magnetized for a period after the crane movement has stopped, thus allowing for a faster start of this variable frequency controlled AC motor drive.

## 2.20 Micro Speed Gain (Optional)

Minimum value:	1%
Maximum value:	100%
Factory setup:	50%

The micro speed functions as a speed limiter. With the micro speed activated, the crane operational speed will be limited to X% of the maximum normal operating speed, where X is the number set in this sub-menu.

### 3.00 Hoist Setup [Hoist Setup]

### Hoist Control

SCS software module needs to know the load pendulum length to operate correctly. This measurement is the only additional signal required compared to normal crane control. To make installation easy, the SCS software module is fitted with two height measurement inputs, analog (4-20mA) or an incremental pulse encoder and home position. Both measurements can be adjusted either manually or experimentally. Manual adjustment is set for the number of pulses per meter or measurement range for 4-20mA analog input. Experimental adjustment, first select 1, 2 or 3 meter test, then start the test. Move the hoist up or down the selected length and end the test. The measurement is then automatically scaled to start from 4mA or from home position (upper end limit switch). If upper end limit is used the input should be in the ON state when the crane hook is in the limit switch area.

#### 3.01 Measurement type [Measurement]

*NOTE: 24VDC for analog measurement provided by the SCS.*

4-20mA

Increment Sensor

(Factory setup)

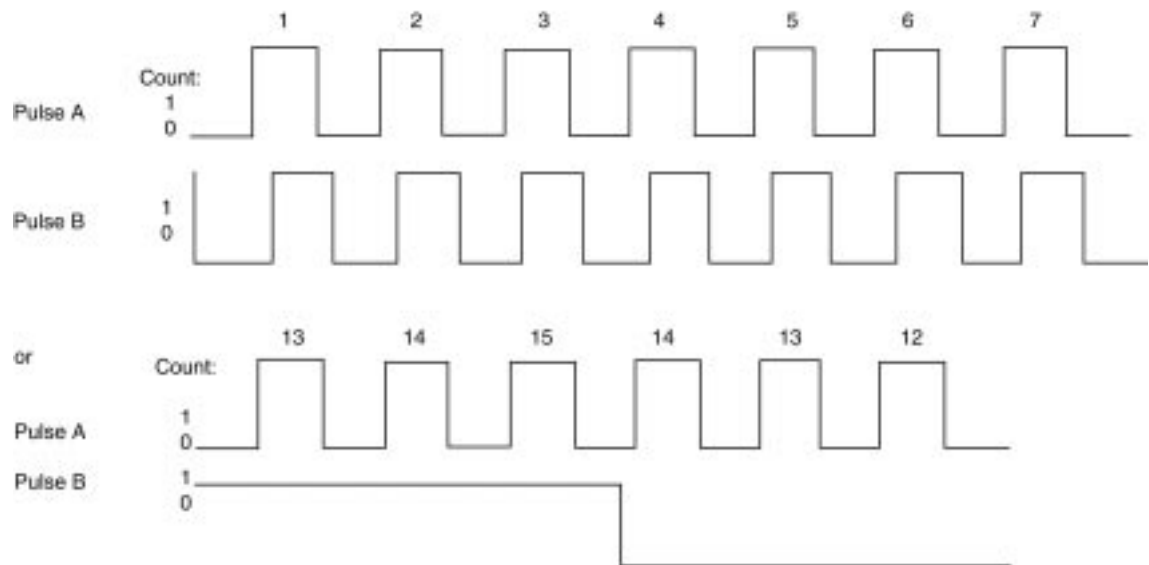

**Figure 2-7: Principle of pulse counting.**

*Pulse A frequency maximum is 500 Hz (500 squared pulses/second). Count operates on every falling edge of the pulseA. Direction of the count is set according to pulse B's state.*

This parameter is used to select the analog input signal or incremental pulse encoder input for the load pendulum length measurement. Analog measurement is 4-20mA and incremental measurement is 500 Hz pulse encoder input. In the pulse encoder input, Pulse A is used for counting and Pulse B is used for count direction sensing. Home position sets count to zero when activated. The measurement assumes that the home position is always on the top end of the hoist movement. Measurement detects the down direction automatically when the home position input goes to OFF state. The maximum number of pulses should never be larger than  $2^{16}-1$  (=35535 pulses). 24 VDC provided by SCS.

## 3.02 Set Scaling Manually [Manual Adj]

### For Incremental Pulse Encoder

100- pulses/meter (Factory setup)

or

### For Absolute Encoder (4-20mA)

Minimum value: 0.5 meter

Maximum value: 20.0 meter

Factory setup: 10.0 meter

User can scale measurement input for hoist height manually:

- If pulse measurement is used the user can set pulses/meter value manually.
- If an analog 4-20 mA input is used, user can set the measurement range between 0-20 meters manually

## 3.03 Test Difference for scaling [Test Range]

1 meter (Factory setup)

2 meter

3 meter

Height measurement can be adjusted manually, or by a simple test. If the test is chosen, the test range (1, 2 or 3 meters) needs to be selected first.

## 3.04 Range Test for Scaling [Auto.Setup]

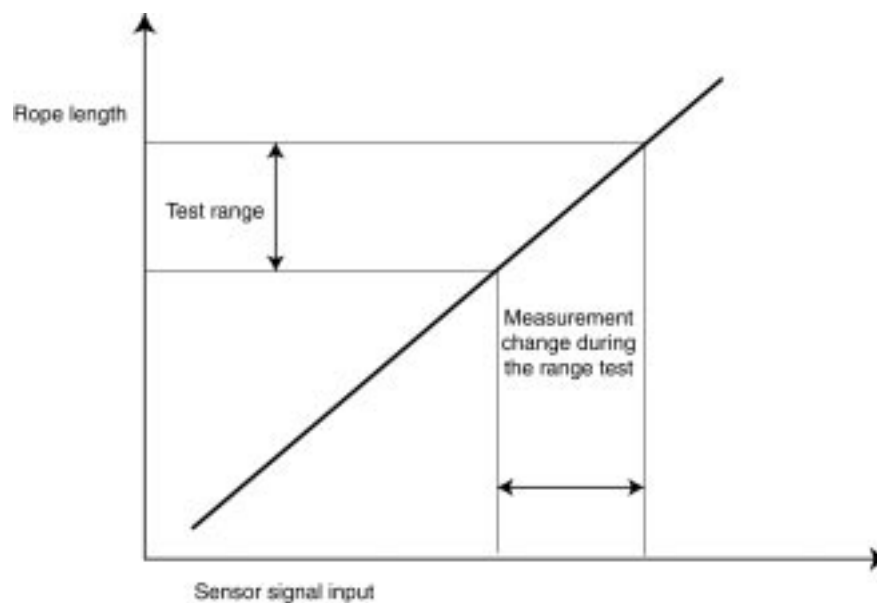

*Figure 2-8: Scaling sets the slope angle of the measurement sensor input versus rope length curve.*

Range test is a practical method to adjust the load height measurement. Make sure the measurement sensor is operating correctly and measurement range does not go over minimum /maximum limits of the analog signal.

1. Select test range (1, 2 or 3 meters), using the previous parameter, test difference for scaling.
2. Start the test using the ENTER key.
3. Press  $\uparrow$  to clear the test count register.
4. Lift the hook exactly the distance set by the parameter 3.03.
5. Stop the test by pressing the ENTER key.

Now the height measured per measurement unit is stored into the SCS software controller's memory. The measurement then expects that at the upper end of the measurement load is in the higher position and the rope length is zero. Since the rope length does not actually GO to zero, the adjustment is made by adding a constant value to the calculated height value, see 3.05 & 3.06 Swing Time/height measurement adjustment.

*NOTE: Cycling power may be required.*

### **3.05 Swing Time/ height measurement adjustment, Bridge [SwingTm.Bridge]**

Minimum value: 1.41, s-12.5 m  
Maximum value: 7.09, s+12.5 m  
Factory setup: 1.41, s0.0m

### **3.06 Swing Time/height measurement adjustment, Trolley [SwingTm.Trolley]**

Minimum value: 1.41, s-12.5 m  
Maximum value: 7.09, s+12.5 m  
Factory setup: 1.41, s 0.0 m

#### **The adjustment for Bridge and Trolley is the same procedure:**

When setting this parameter, the sling length is recommended to be set for 0 meters. When the hook is empty. Since the rope length never actually goes to zero, the adjustment is made by adding a constant value to the calculated height value. The correct value is set using the following steps. A test should be conducted.

Measure the swing time by using a stop watch. To get a good measurement value it is recommended to measure the time of several swing periods and then divide the time by the number of periods to get the time for one period. Increase or decrease the adjustment value using up/down keys ( $\uparrow$  plus,  $\downarrow$  Minus) until the swing time displayed is the same as you measured.

Test the operation by stopping the crane and dampening all swing of the load. Give a short speed command, about one second long and let the crane move a short distance. Observe the load sway. If the load and the crane stop exactly at the same time and there is no end sway the load height measurement is correct. Repeat the test on several different heights to ensure that the measurement is correct over the whole height range.

If there is end sway after the above test, we need to detect when the crane stops and what the load position is at that moment. If the crane stops too soon or before the load has reached the lowest position (exactly under the pivot point) the measured load pendulum length is too short. If the crane continues moving too long and the load sways over the lowest point under the pivot point before the crane stops, the load height measurement value is too long.

## Hoist Control

Increase and decrease the adjustment value according to the above test result and repeat the test until you have acceptable crane operation. Please note while making this test the SCS software algorithm must be activated and the sling length must be set to zero.

In most systems, setting up the height measurement using range test and swing time renders a good result. If your application requires better end sway, double-check swing time on different heights.

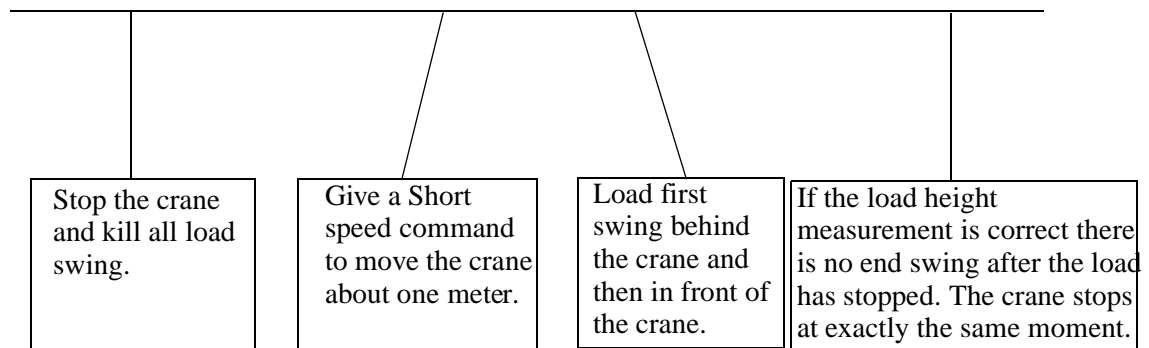

**Figure 2-9: Load sway test, when the load pendulum length is set correctly.**

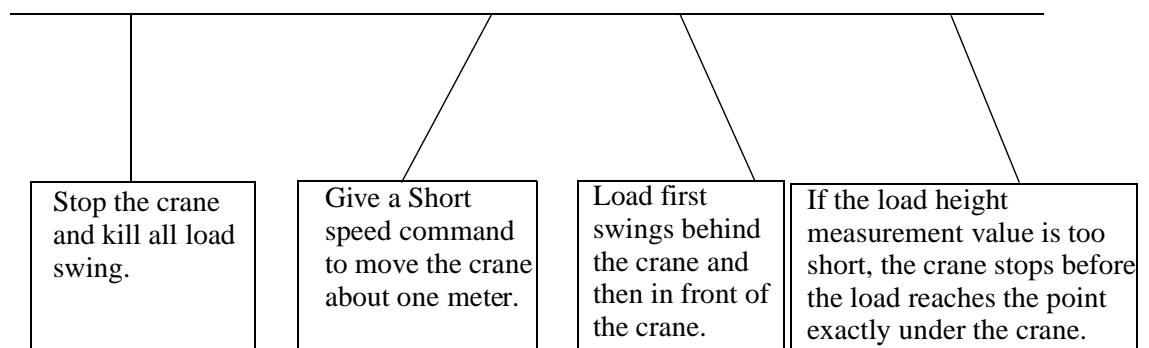

**Figure 2-10: Load sway test, when the measured load pendulum length is too short**

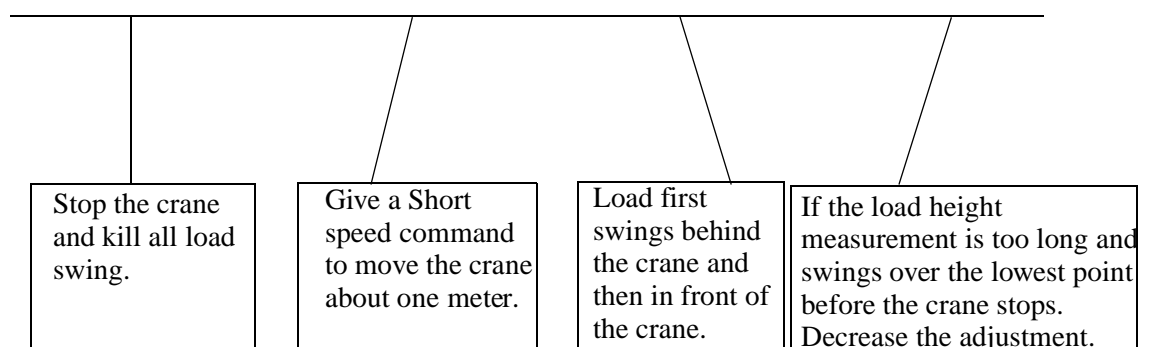

**Figure 2-11: Load sway test, when the measured load pendulum length is too long.**



## **4.00 Options [Options]**

### **4.01 Return Factory Defaults [Factory Default]**

Enter->YES ESC->NO

Restores the factory setup values. All parameters are replaced.

### **4.02 Software Version [Soft. Version]**

SCS Version 1.01

By pressing the ENTER button you can see the currently loaded software version.

# Calibration for Input and Output (I/O)

Security Code 2 (40000)

## 5.00 IO-Configuration [I/O-config]

The following parameters are adjusted by manufacturer. They are used to scale inputs and outputs. To change this value you have to make some connections to the module. Use a power supply of 24V DC.

*NOTE: The values in display texts in the following pages are examples and may be different.*

Before making any adjustments, make sure you have selected the following parameter values:

Bridge & Trolley

1. & 2.07	Mode:	Proportional, smooth
1. & 2.09...1. & 2.12		
Limit Switches:	not used	(factory setup)
1. & 2.13	Input:	0-10V + Directions
1. & 2.14	Output:	0-10V + Directions (Fa. setup)

Hoist Setup:

3.01	Measurement:	4-20mA
------	--------------	--------

### 5.01 Bridge In 10V [Bridge IN 10V]

This parameter stores the value for the 10 volt input. Apply exactly 10.00V to the analog bridge input. The display shows the following:

5.01 Bridge IN 10V  
02920 Mess: 02858

The left value on the display is the old value, the right value is the new value measured by the unit. By pressing ENTER the new value is stored and will be used for input scaling.

### 5.02 Bridge In 20mA [Bridge IN 20mA]

Change Parameter:

Bridge: 1.13            Input: 4-20mA +Directions

Apply exactly 20.00 mA to the analog bridge input. The display shows the following:

5.02 Bridge IN 20mA  
03120 Mess:03344

The left value on the display is the old value, the right value is the new value measured by the unit. By pressing ENTER the new value is stored and will be used for input scaling.

### **5.03 Bridge In 4mA [Bridge IN 4mA]**

Apply exactly 4.00mA to the analog bridge input. The display shows the following:

5.03 Bridge IN 4mA  
00620 Mess:00575

The left value on the display is the old value, the right value is the new value measured by the unit. By pressing ENTER the new value is stored and will be used for input scaling.

### **5.04 Trolley In 10V [Trolley IN 10V]**

Apply exactly 10.00V to the analog trolley input. The display shows the following:

5.04 Trolley IN 10V  
02920 Mess:02858

The left value on the display is the old value, the right value is the new value measured by the unit. By pressing ENTER the new value is stored and will be used for input scaling.

### **5.05 Trolley In 20mA [Trolley IN 20mA]**

Change Parameter:

Trolley: 2.13                      Input: 4-20mA +Directions

Apply exactly 20.00mA to the analog trolley input. The display shows the following:

5.05 Trolley IN 20mA  
03120 Mess: 03344

The left value on the display is the old value, the right value is the new value measured by the unit. By pressing ENTER the new value is stored and will be used for input scaling.

### **5.06 Trolley In 4mA [Trolley IN 4mA]**

Apply exactly 4.00mA to the analog trolley input. The display shows the following:

5.06 Trolley IN 4mA  
00620 Mess:00575

The left value on the display is the old value, the right value is the new value measured by the unit. By pressing ENTER the new value is stored and will be used for input scaling.

### **5.07 Height Measurement 20mA [Height Meas 20mA]**

Apply exactly 20.00mA to the analog height measurement input. The display shows the following:

5.07 HeightMeas 20mA  
03120 Mess:03344

The left value on the display is the old value, the right value is the new value measured by the unit. By pressing ENTER the new value is stored and will be used for input scaling.

### **5.08 Height Measurement 4mA [Height Meas 4mA]**

Apply exactly 4.00mA to the analog height measurement input. The display shows the following.

5.08 Height Meas 4mA  
00620 Mess:00567

The left value on the display is the old value, the right value is the new value measured by the unit. By pressing ENTER the new value is stored and will be used for input scaling.

### **5.09 Bridge Out 10V [Bridge OUT 10V]**

Change parameter:

Bridge: 1.07                      Mode: 3 Step, smooth  
          1.13                      Input: digital

Change to 5.09 Bridge Out 10V. The display shows the following:

5.09 Bridge OUT 10V  
03340

Connect a voltmeter to the analog bridge output. Connect the bridge right, bridge 2.step, bridge 3.step and the main input with the 24V DC supply. The bridge output goes up to about 10V. By pressing the ↑ or ↓ button you can adjust the output to exactly 10V. Then press ENTER to store the new value.

### **5.10 Bridge Out 20mA [Bridge OUT 20mA]**

Change Parameter:

Bridge: 1.14                      Output: 4-20mA +Direction

Change to 5.10 Bridge Out 20mA. The display shows the following:

5.10 Bridge OUT 20mA  
03340

Connect an ampere meter to the analog bridge output. Connect the bridge right, bridge 2.step, bridge 3.step and the main input with the 24V DC supply. The bridge output goes up to about 20mA. By pressing the ↑ or ↓ button you can adjust the output to exactly 20mA. Then press ENTER to store the new value.

### **5.11 Bridge Out 4mA [Bridge OUT 4mA]**

The display shows the following:

5.11 Bridge OUT 4mA  
00630

Connect an ampere meter to the analog bridge output. The bridge output goes up to about 4mA. By pressing the ↑ or ↓ button you can adjust the output to exactly 4mA. Then press ENTER to store the new value.

### **5.12 Trolley Out 10V [Trolley OUT 10V]**

Change Parameter:

Trolley: 2.13                      Input: digital  
          2.07                      Mode: 3 Step, smooth

Change to 5.12 Trolley Out10V. The display shows the following:

5.12 Trolley OUT 10V  
03340

Connect a voltmeter to the analog trolley output. Connect the trolley right, trolley 2.step, trolley 3.step and the main input with the 24V DC supply. The trolley output goes up to about 10V. By pressing the ↑ or ↓ button you can adjust the output to exactly 10V. Then press ENTER to store the new value.

### **5.13 Trolley Out 20mA [Trolley OUT 20m]**

Change Parameter:

Trolley: 2.14                      Output: 4-20mA+Direction

Change to 5.13 Trolley Out 20mA. The display shows the following:

5.13 Trolley OUT 20mA  
03340

Connect an ampere meter to the analog trolley output. Connect the trolley right, trolley 2.step, trolley 3.step and the main input with the 24VDC supply. The trolley output goes up to about 20mA. By pressing the ↑ or ↓ button you can adjust the output to exactly 20mA. Then press ENTER to stop the new value.

### **5.14 Trolley Out 4mA [Trolley OUT 4m]**

This display shows the following:

5.14 Trolley OUT 4m  
00630

Connect an ampere meter to the analog trolley output. The trolley output goes up to about 4mA. By pressing the ↑ or ↓ button you can adjust the output to exactly 4mA. Then press ENTER to store the new value.

## **6.00 Serial I/O Configuration [Serial I/O]**

If the serial input is used for connecting a remote control unit, the used digital and analog channels can have different functions.

### **6.01 Trolley right [Trolley right]**

Minimum value: DK03

Maximum value: DK29

Factory setup: DK06

### **6.02 Trolley left [Trolley left]**

Minimum value: DK03

Maximum value: DK29

Factory setup: DK05

### **6.03 Trolley 2.Step [Trolley 2.step]**

Minimum value: DK03

Maximum value: DK29

Factory setup: DK13

### **6.04 Trolley 3.Step [Trolley 3.step]**

Minimum value: DK03

Maximum value: DK29

Factory setup: DK14

### **6.05 Trolley AK IN [Trolley AK in]**

Minimum value: AK1

Maximum value: AK8

Factory setup: AK2

### **6.06 Trolley AK OUT [Trolley AK out]**

Minimum value: AK1

Maximum value: AK8

Factory setup: AK2

### **6.07 Bridge right [Bridge right]**

Minimum value: DK03

Maximum value: DK 29

Factory setup: DK08

### **6.08 Bridge left [Bridge left]**

Minimum value: DK03

Maximum value: DK29

Factory setup: DK07

### **6.09 Bridge 2.Step [Bridge 2.step]**

Minimum value: DK03  
Maximum value: DK29  
Factory setup: DK15

### **6.10 Bridge 3.Step [Bridge 3.step]**

Minimum value: DK03  
Maximum value: DK29  
Factory setup: DK16

### **6.11 Bridge AK IN [Bridge AK in]**

Minimum value: AK1  
Maximum value: AK8  
Factory setup: AK3

### **6.12 Bridge AK OUT [Bridge AK Out]**

Minimum value: AK1  
Maximum value: AK8  
Factory setup: AK3

### **6.13 Sling D0 [Sling D0]**

Minimum value: DK03  
Maximum value: DK29  
Factory setup: DK26

### **6.14 Sling D1 [Sling D1]**

Minimum value: DK03  
Maximum value: DK29  
Factory setup: DK27

### **6.15 Sling D2 [Sling D2]**

Minimum value: DK03  
Maximum value: DK29  
Factory setup: DK28

### **6.16 Sling D3 [Sling D3]**

Minimum value: DK03  
Maximum value: DK29  
Factory setup: DK29

## **Application Notes:**

1. Parallel inputs wiring. If parallel inputs are in use with decoder modules (Electromotive Systems Decoder), there is a series of resistors of 1k that need to be added on each digital (5V) inputs to prevent over current in the input line when SCS is off.
2. After adjusting the height measurements, SCS needs to be reset by cycling power.



This page intentionally left blank.

*A p p e n d i x* **A**

---

**Servicing  
SCS**

This page intentionally left blank.

# Service

This chapter includes information pertaining to on-call service, drive identification, troubleshooting, and warranty. Before you install, troubleshoot, or service the drive, we highly recommend you read this entire chapter. Doing this will help assure quick service response, minimize your on-site repair costs, and reduce crane downtime.

Your *SCS Module* includes a two-year warranty from date of shipment. The warranty is described in detail later in this chapter. The absolute encoder includes a one year warranty from time of shipment.

## On-Call Service

If you ever require our assistance, contact us at (800) 288-8178; our fax number is (800) 298-3508. Technical support is available 24 hours a day, seven days a week, and 365 days a year. If necessary, we can arrange to have a Service Technician visit your site to evaluate the situation.

## Service Policy For SCS Components

This section explains Electromotive Systems' service policy for the SCS components.

Should your *SCS* product fail during the warranty period, Electromotive Systems will repair or replace your unit within 72 hours (3 working days). In most cases, we can supply a replacement unit within 24 hours (1 working day). If the problem is not covered under warranty, you are responsible for the cost of the repairs and the shipping charges.

To return a failed unit (or part):

1. Request a Return Authorization (RA) from Electromotive Systems' Service Department, as a condition for us to repair or replace the unit. Return the failed unit to Electromotive Systems **via pre-paid freight**. When you call, please have the serial number of the drive available and be prepared to provide the information requested on the Return Authorization Information Sheet found on page A-4.
2. A purchase order or credit card is required to cover the cost of the replacement unit or repairs to a returned unit.

Electromotive Systems will inspect the failed unit and determine if the unit is covered under warranty.

- If the unit is covered under warranty, Electromotive Systems will credit the cost of the replacement unit and/or repairs and reimburse you for all reasonable freight charges.

***NOTE:*** *Freight charges incurred from sources other than common ground carriers WILL NOT be reimbursed unless pre-approved by Electromotive Systems.*

- If the unit is not covered under warranty, Electromotive Systems will bill you for the cost of the replacement unit or the cost of repairs. Electromotive Systems will also bill you for a \$125.00 inspection fee (this fee will be waived if repairs are made to the unit) and any freight charges incurred by Electromotive Systems.

ELECTROMOTIVE SYSTEMS  
**RETURN AUTHORIZATION INFORMATION SHEET**

To Expedite Processing Complete This Form

Please complete lines 5 through 15. If you have any questions regarding the completion of this form contact Electromotive Systems Service Department at 800-288-8178.

1. Return Authorization Number: RA \_\_\_\_\_ Issue Date   /  /
2. Customer \_\_\_\_\_
3. Customer P.O. Number \_\_\_\_\_
4. Contact Name \_\_\_\_\_ Phone \_\_\_\_\_ Fax \_\_\_\_\_
5. End User (name/location) \_\_\_\_\_
6. Component Model \_\_\_\_\_
7. Component Serial Number \_\_\_\_\_

ABOVE MATERIAL TO BE RETURNED VIA PRE-PAID FREIGHT TO:

Electromotive Systems  
N49 W13650 Campbell Drive  
Menomonee Falls, WI 53051

Please enclose a copy of this form with material to be returned and mark RA number clearly on shipping container

APPLICATION INFORMATION

8. Type of application (i.e., Mill, Log Handling, Standard Industrial): \_\_\_\_\_
9. Crane Duty Cycle: CMAA A B C D E F (circle)
10. Motion:  Main Hoist  Aux Hoist  Bridge  Trolley  
Other (please specify) \_\_\_\_\_
11. Describe conditions under which problem occurred \_\_\_\_\_
12. Make/Model Dynamic Braking Resistor: \_\_\_\_\_
13. Line Voltage  230  460  575  Other (specify) \_\_\_\_\_
14. Motor Information: Qty  1  2  Other (please specify) \_\_\_\_\_  
\_\_\_\_\_ Motor RPM \_\_\_\_\_ Nameplate Full Load Amps
15. Reactors used  Line  Load  None

FOR WARRANTY INFORMATION SEE BACK OF THIS FORM

Control number 1584

Original Date: 04/08/97

Rev 00 Page 1 of 1

## Electromotive Systems Limited Warranty

Electromotive Systems, hereafter referred to as Company, guarantees all items manufactured by it against any defects of material and/or workmanship for a period of two years from the date of shipment. Company makes NO OTHER WARRANTY, EXPRESSED OR IMPLIED, AS TO THE MERCHANTABILITY OR FITNESS OF THE ITEMS FOR THEIR INTENDED USE OR AS TO THEIR PERFORMANCE. Any statement, description or specification in Company's literature is for the sole purpose of identification of items sold by the Company and imparts no guarantee, warranty or undertaking by company of any kind. Components and accessories not manufactured by Electromotive Systems are not included in this warranty and are warranted separately by their respective manufacturers.

Company's sole liability shall be to repair at its factory, or replace any item returned to it within two years (except as noted) from date of shipment, which Company finds to contain defective material or workmanship. All items to be repaired or replaced shall be shipped to Company (Note: return authorization by Company is required) within said two year period, freight prepaid, as a condition to repair or replace defective material or workmanship. Company's herein assumed responsibility does not cover defects resulting from improper installation, maintenance, or improper use. Any corrective maintenance performed by anyone other than the Company during the warranty period shall void the warranty. Company shall not be liable for damages of any kind from any cause whatsoever beyond the price of the defective Company supplied items involved. Company shall not be liable for economic loss, property damage, or other consequential damages or physical injury sustained by the purchaser or by any third party as a result of the use of any Company supplied items or material.

Company neither assumes nor authorizes any other person to assume for Company any other liability in connection with the sale or use of items sold by Company.

Materials or items may not be returned for credit, without the prior written consent of the Company. Any authorized return of materials or items shall be subject to a restocking charge equal to 25% of the net invoiced amount (\$100 minimum charge for all control products) after Company determines that the material or item is in resalable condition. If upon receipt of the material or items returned, the Company determines that said material or items cannot be resold without alteration or service, the Company reserves the right to reject the returned materials or items and to send the same back to said purchaser at purchaser's expense.

Any claim for errors in shipment or for material or time shortages must be received by Company within 30 days of shipment and must be accompanied by copies of the bill of lading and packing slip.

This page intentionally left blank.